

**QAA73.110
PROGRAMMABLE ROOM UNIT**

For Single Boiler Applications

**Installation, Commissioning
and Operating Instructions**

IMPORTANT NOTE

**THESE INSTRUCTIONS MUST BE READ
AND UNDERSTOOD BEFORE INSTALLING,
COMMISSIONING, OPERATING OR
SERVICING EQUIPMENT**

Customer Services

Technical Enquiries



01202 662527/662528

To supplement the detailed technical brochures, technical advice on the application and use of products in the Hamworthy Heating range is available from our technical team in Poole and our accredited agents.

Site Assembly



01202 662555

Hamworthy offer a service of site assembly for many of our products in instances where plant room area is restricted. Using our trained staff we offer a higher quality of build and assurance of a boiler built and tested by the manufacturer.

Commissioning



01202 662555

Commissioning of equipment by our own engineers, accredited agents or specialist sub – contractors will ensure the equipment is operating safely and efficiently.

Maintenance Agreements



01202 662555

Regular routine servicing of equipment by Hamworthy service engineers inspects the safety and integrity of the plant, reducing the risk of failure and improving performance and efficiency. Maintenance agreements enable our customers to plan and budget more efficiently.

Breakdown service, repair, replacement



01202 662555

Hamworthy provide a rapid response breakdown, repair or replacement service through head office at Poole and accredited agents throughout the UK.

Spare Parts



01202 662525

A comprehensive spare parts service is operated from our factory in Poole, providing replacement parts for both current and discontinued products. Delivery of parts and components is normally from stock within seven days. However, a next day delivery service is available for breakdowns and emergencies.

QAA73.110
PROGRAMMABLE ROOM UNIT

For Single Boiler Applications

**Installation, Commissioning
and Operating Instructions**

**NOTE: THESE INSTRUCTIONS SHOULD BE READ AND UNDERSTOOD BEFORE
ATTEMPTING TO INSTALL, COMMISSION OR OPERATE THIS UNIT**

PUBLICATION NO. 500001140
ISSUE 'A'
JULY 2005

HAMWORTHY HEATING LTD

i
QAA73.110
Programmable Room Unit

500001140/A

CONTENTS

	PAGE
1.0 Introduction	1
2.0 Handling and Installation	2
2.1 Location	
2.2 Installation	
2.3 Electrical installation	
3.0 Commissioning	5
4.0 Operation	10
5.0 Fault Finding	12
6.0 Technical Data	12
7.0 Single Heating Zone Installations	13
8.0 Single Heating Circuit with Domestic Hot Water	18
9.0 Twin Heating Circuits with Domestic Hot Water	24
Appendix A: Sensors	32

1.0 Introduction

The Hamworthy QAA73.110 is a digital multi-functional room unit for one or 2 heating circuits and d.h.w. control.

Used in plant having Wessex ModuMax boilers, the boiler control LMU64 delivers the outside temperature and other information to the QAA73.110 room unit via the OpenTherm communication interface. Based on the outside temperature, the room temperature and a number of other parameters, the interface calculates the required flow temperature setpoints for one or 2 heating circuits and transmits them to the boiler control. In addition, the d.h.w. temperature setpoint is transmitted to the boiler control.

The optimization and weather compensation functions offer energy savings without sacrificing comfort. The room sensor required for that purpose is integrated within unit.

Features

- Operating sections (operating levels) based on ergonomic and functional considerations
- Clear assignment of basic functions:
- Operating mode, setpoint adjustment and occupancy button
- A number of actual values can be accessed via the Info button
- Additional functions can be programmed after opening the cover
- Special service level with protected access
- Every setting or change is displayed and thus acknowledged
- Yearly clock with automatic summer- / wintertime changeover
- One heating program per heating circuit with up to 3 heating periods per day can be selected on an individual basis



- D.h.w. program with up to 3 heating periods per day can be selected on an individual basis
- Holiday program
- The heating programs and the d.h.w. program can be reset to their default settings
- Programming lock (e.g. for child-proofing)
- Clear text display in a number of selectable languages
- Special mode for setting the parameters of Siemens boiler control systems
- Weather-compensated flow temperature control while giving consideration to the building's thermal dynamics
- Weather-compensated flow temperature control with room compensation
- Pure room temperature control
- Effect of room temperature deviation can be adjusted
- Optimum start / stop control
- ECO functions (24-hour limit switch, automatic summer / winter changeover)
- Room temperature switching differential for limiting the room temperature
- Adjustable maximum limit of flow temperature (especially in connection with floor heating systems)
- Limitation of the rate of increase of the flow temperature setpoint
- Frost protection for the building, frost warning
- D.h.w. control with release and pre-selection of setpoint for the boiler controller
- Anit-legionella function
- Integrated yearly clock with a reserve of at least 12 hours
- Elegant housing made of recyclable plastic
- Communication with the boiler control via OpenTherm interface
- Power supply via OpenTherm interface

Range of Products

- Boiler Management Unit Premix TOP LMU64
- Third party boiler control with OpenTherm interface Room unit with OpenTherm interface QAA73.110
- Mounting clips for panel mounting AVS92.299

Product Liability

- When using the products, all requirements specified under 'Technical Data' must be observed
- The local regulations for electrical installation must be complied with.

2.0 Handling and installation

2.1 Location

- In the main occupancy room or reference room
- The place of installation should be chosen so that the sensor can capture the room temperature as accurately as possible, without being affected by direct solar radiation or other heating or cooling sources
- Mounting height should be approximately 1.5 meters above the floor
- The unit can be fitted to most commercially available recessed conduit boxes or directly on the wall

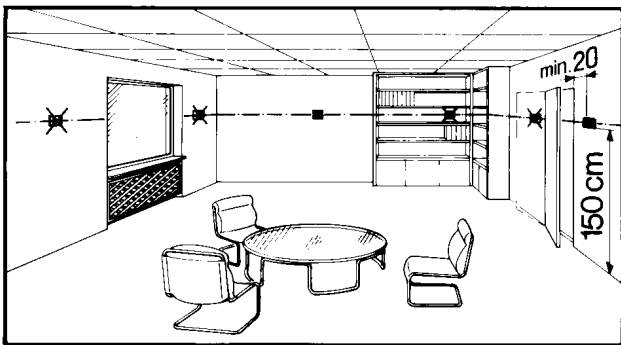

2.2 Installation

- Wall
- Boiler control panel (with the help of clips)

The controller may not be exposed to dripping water
Permissible ambient temperature: 0...50 °C

Wall Mounting

Open the unit at the top and remove the base from the housing front.

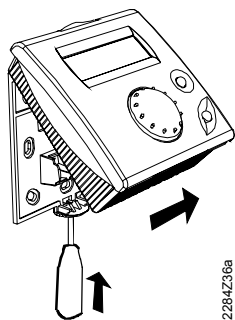

Fit the base to the wall with screws.

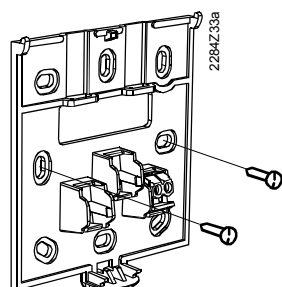

Pull the interface cable through the opening of the base and connect it to the screw terminals.

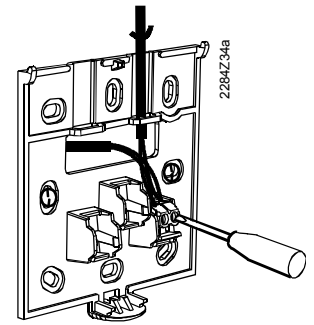

Engage the housing front at the top of the base and close the unit to the bottom.

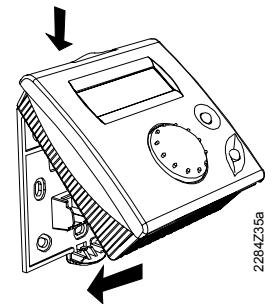

Control Panel Mounting

Pull the interface cable through the opening of the base and connect it to the screw terminals.

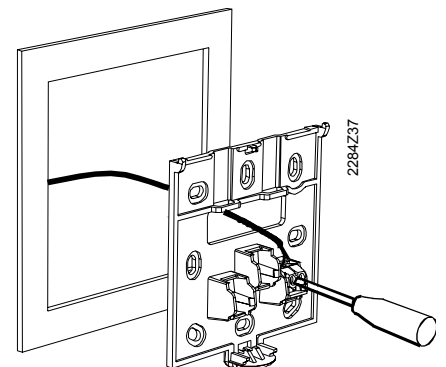

Engage the housing front at the top of the base and close the unit to the bottom.

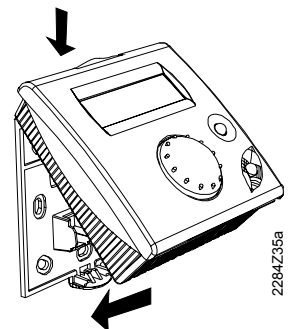

Slide the unit into the panel cut-out without applying any force.

Note: Do not use any tools when inserting the unit into the cut-out. If it does not fit, check the size of the cut-out and the housing.

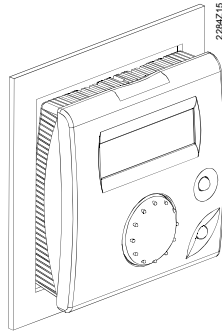

Fit the clips (usually 4 pieces) to the rear of the housing. They engage on the housing.

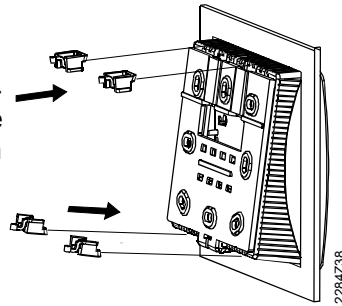

Cut-Out Details

The controller's mounting dimensions are 92 x 92mm

However, due to the dimensions of the front the standard spacing is 96mm.

The mechanical mounting facility allows the controller to be fitted in front panels having a thickness of 1 to 2.5mm.

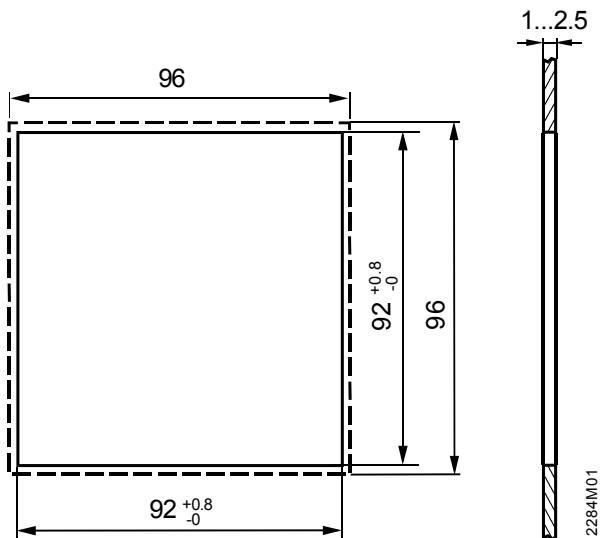

2.3 Electrical Installation

The local regulations for electrical installations must be complied with.

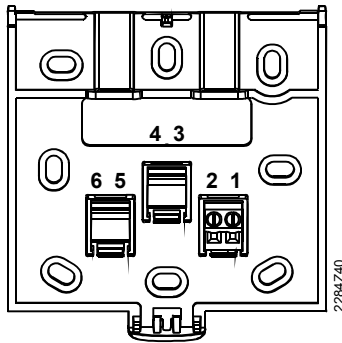

- 1 COA Open Therm terminal A (interchangeable)
- 2 COB Open Therm terminal B (interchangeable)
- 3 - -
- 4 - -
- 5 - -
- 6 - -

Note: 23mA max.

OpenTherm Communication Interface

For protection of the OpenTherm interface from electromagnetic disturbance, cables used for the OPENTHERM INTERFACE connections should be completed using shielded two core cable. Preference should be given to wire mesh shielded twisted cables.

In the installation the two ends of the cable must be connected to a reference potential (building ground).

To further protect the OPENTHERM INTERFACE from electromagnetic disturbance these should be separated from mains cables, preferably run in separate conduits or ducts. Where mains cables and OPENTHERM INTERFACE cables must be run in the same duct a central divider should be used to separate the OPENTHERM INTERFACE cables from the mains cables.

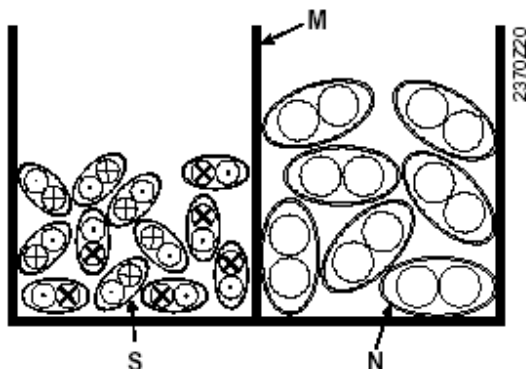

OPENTHERM INTERFACE Power Supply

The power supply for the OpenTherm communication interface and the QAA73 room controller is supplied from the boiler LMU64 controller.

Cables used for installing the OpenTherm communication interface power supply must have cross-sectional area of 1.5mm².

OpenTherm Communication Interface Cable Lengths

Using non interchangeable copper cable 1.5mm² the maximum permitted Interface cable length, including all branches, is 50 metres.

Connecting the Interface cable

The OpenTherm communication interface cable must be connected to terminals GND(-) and LINE(+) of the LMU64 and terminals 1 & 2 of the QAA73 room controller. The room controller terminals are volt free therefore polarity is not critical.

Communication with boiler control

For communication between the QAA73.110 and boiler control, the OpenTherm Plus protocol is used.

The parameters displayed only in OpenTherm Plus mode are appropriately identified in the parameter lists.

The following descriptions of the individual parameters refer to the use of OpenTherm Plus and are based on the assumption that the relevant functions are supported by boiler control. Only then is the full functionality of the QAA73.110 ensured so that the most common applications can be fully covered

If a parameter is not supported by boiler control, the display shows 3 strokes – – – in place of a value

3.0 Commissioning

Prior to commissioning the controller, make the following checks:







- Correct mounting
- Correct connection to OpenTherm interface
- Enduser parameters are set as required
- Heating engineer parameters are set in compliance with plant requirements
- OEM parameters are set in compliance with technical requirements

The heating plant is started up via boiler control. To make the functional check, the individual functions of the room unit are checked in the plant.

Parameter Settings for the Enduser.

The following settings can be made to meet the individual needs of the enduser.

For specific applications and details regarding which parameters to change please refer to the relevant section of this manual.

	Buttons	Explanation	Line
1		Press one of the 2 line selection buttons. <i>This will take you to the programming level 'Enduser'</i>	
2		Press the line selection buttons to select the required line. <i>The parameter list on the following pages contain all available lines.</i>	 
3		Press the + or - button to set the required value. The setting will be stored as soon as you leave the programming mode or change to another line. <i>The parameter list on the following pages contains all settings that can be made.</i>	
4		By pressing the info button, you leave the programming level 'Enduser' Note: <i>If no button is pressed for about 8 minutes, the room unit will automatically return to the 'Info' Level.</i>	Contin. display

Overview of Enduser Parameters:

Line	Function	Range	Unit	Resolution	Factory Setting
Setting the Clock					
1	Time of Day	0... 23:59	hh:min	1 min	-
2	Date (day, month)	1. Jan... 31. Dec	dd.mm	1 day	-
3	Year	2000... 2094	jjjj	1 year	-
Setpoints					
5	Reduced room temperature setpoint (TRRw)	TRF ... TRN	°C	0.5	16.0
6	Frost protection setpoint of room temperature (TRF)	TRRw	°C	0.5	10.0
7*	Nominal setpoint of the d.h.w. temperature (TBWw)	TBWR ... TBWmax	°C	1	55
Time Switch Program 1 (heating circuit 1)					
10	Pre-selecting the weekday	Mo...Su, week	Week-day	1 day	-
11	Switch-on time period 1	—:— / 00:00... 24:00	hh:mm	10 min	06:00
12	Switch-off time period 1	—:— / 00:00... 24:00	hh:mm	10 min	22:00
13	Switch-on time period 2	—:— / 00:00... 24:00	hh:mm	10 min	—:—
14	Switch-off time period 2	—:— / 00:00... 24:00	hh:mm	10 min	—:—
15	Switch-on time period 3	—:— / 00:00... 24:00	hh:mm	10 min	—:—
16	Switch-off time period 3	—:— / 00:00... 24:00	hh:mm	10 min	—:—
Time Switch Program 2					
20*	Pre-selecting the weekday	Mo...Su, week	Week-day	1 day	-
21*	Switch-on time period 1	—:— / 00:00... 24:00	hh:mm	10 min	06:00
22*	Switch-off time period 1	—:— / 00:00... 24:00	hh:mm	10 min	22:00
23*	Switch-on time period 2	—:— / 00:00... 24:00	hh:mm	10 min	—:—
24*	Switch-off time period 2	—:— / 00:00... 24:00	hh:mm	10 min	—:—
25*	Switch-on time period 3	—:— / 00:00... 24:00	hh:mm	10 min	—:—
26*	Switch-off time period 3	—:— / 00:00... 24:00	hh:mm	10 min	—:—
Time Switch program 3 (d.h.w.)					
30*	Pre-selecting the weekday	Mo...Su, week	Week-day	1 day	-
31*	Switch-on time period 1	—:— / 00:00... 24:00	hh:mm	10 min	06:00
32*	Switch-off time period 1	—:— / 00:00... 24:00	hh:mm	10 min	22:00
33*	Switch-on time period 2	—:— / 00:00... 24:00	hh:mm	10 min	—:—
34*	Switch-off time period 2	—:— / 00:00... 24:00	hh:mm	10 min	—:—
35*	Switch-on time period 3	—:— / 00:00... 24:00	hh:mm	10 min	—:—
36*	Switch-off time period 3	—:— / 00:00... 24:00	hh:mm	10 min	—:—
Holidays					
40	Holidays start (day.month) — Inactive	1.Jan ... 31.Dec	dd.mm	1 day	—:—
41	Holidays end (day.month) — : Inactive	1.Jan ... 31.Dec	dd.mm	1 day	—:—
42	Heating circuit operating level during holidays	Frost, reduced	-	-	Frost
General					
45	STANDARD time switch programs for HC1+2 and d.h.w. (press both +/- buttons for 3 seconds)	No, Yes	-	-	No
46	Summer / winter changeover temperature	8... 30	°C	0.5	17.0

Continued on next page...

Continued from previous page...









Line	Function	Range	Unit	Resolution	Factory Setting
47	Language	German, English	-	1	German
50*	Display of fault (error code of QAA73.110 or Boiler control)	0 ... 255	-	1	-

*These lines are only displayed in OpenTherm Plus mode. Also, the relevant functions must be supported by boiler control.

—:— = Switching point inactive.

Parameter Settings for the Heating Engineer

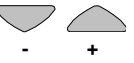
Room unit configuration and parameter settings to be made by the heating engineer. For specific applications and details regarding which parameters to change please refer to the relevant section of this manual.

	Buttons	Explanation	Line
1		Press one of the 2 line selection buttons. <i>This will take you first to the programming level 'Enduser'</i>	
2		Press both line selection buttons for at least 3 seconds <i>This will take you to the programming level 'Heating Engineer'</i>	
3		Press the line selection buttons to select the required line. <i>The parameter list on the following contains all of the available lines.</i>	 ... 98
4		Press the + or - button to set the required value. The setting will be stored as soon as you leave the programming mode or change to another line. <i>The parameter list on the following pages contains all settings that can be made.</i>	
5		By pressing the 'Info' button, you leave the programming level 'Heating Engineer'. → Note: <i>If no button is pressed for about 8 minutes, the room unit will automatically return to the operating mode selected last.</i>	Contin. display

Overview of Heating Engineer Parameters:

Line	Function	Range	Unit	Resolution	Factory Setting
Service Values					
51	Current room temperature setpoint HC1 Nominal, reduced or protection setpoint	4 ... 35.0	°C	0.5	-
52*	Current room temperature setpoint HC2 Nominal, reduced or frost protection setpoint	4 ... 35.0	°C	0.5	-
53*	Outside temperature attenuated (is set to actual value by pressing both +/- buttons for 3 seconds)	-50 ... +50	°C	0.5	-
54*	Outside temperature composite	- 50 ... +50	°C	0.5	-
55*	Actual value 2 of d.h.w. temperature	0 ... 127	°C	1	-
56	D.h.w. flow rate	0 ... 16	l/min	0.5	-
57*	Actual boiler return temperature	-40 ... 127	°C	1	-
58*	Actual value of flue gas temperature	-40 ... 500	°C	1	-
59*	Actual temperature of solar collector	-40 ... 250	°C	1	-
61*	Actual temperature of solar storage tank	-40 ... 127	°C	1	-
62	Open Therm mode	Lite, Plus	-	-	-
63	Current flow temperature setpoint HC1	0... 100	°C	1	-
64*	Current flow temperature setpoint HC2	0... 100	°C	1	-
Frost Protection for the Plant (HK1 and HK2)					
70	Heating curve slope HC1 — = HC1 Inactive	2.5 ... 40.0	-	0.5	15.0
71	Minimum limitation of flow temperature HC1 (TV1 min)	8 ... TV1max	°C	1	8
72	Maximum limitation of flow temperature HC1 (TV1 max)	TV1minTKmax	°C	1	80
73	Parallel displacement of heating curve HC1	- 4.5 ... + 4.5	K	0.5	0.0
74*	Type of building construction	Heavy, Light	-	-	Light
75*	Room influence	None, on HC1, on HC2, on HC1 +	-	-	On HC1
76	Switching differential of room temperature (switch-off point) —.— = inactive	0.5 ... 4.0	K	0.5	0.5
77	Adaptation of the heating curve	Inactive, active	-	-	Active
78	Optimum start control maximum forward shift	0 ... 360	min	10	100
79	Optimum stop control maximum forward shift	0 ... 360	min	10	30
80*	Heating curve slope HC2 —.- = H2 inactive	2.5 ... 40.0	-	0.5	15.0
81*	Minimum limitation of flow temperature HC2 (TV2min)	8 ... TV2max	°C	1	8
82*	Maximum limitation of flow temperature HC2 (TV2max)	TV2min... .. TKmax	°C	1	80
83*	Parallel displacement of heating curve HC2	- 4.5 ... +4.5	K	0.5	0.0
D.h.w					
90*	Reduced setpoint of d.h.w. temperature (TBWR)	8... TBWw	°C	1	40
91	Release of d.h.w. heating	24h/day, TSP HC - 1h, TSP HC, TSP d.h.w.	-	-	Tsp HC - 1h
92*	Legionella function	Off, weekly, daily	-	-	Week;y

Line	Function	Range	Unit	Resolution	Factory Setting
93*	Operating mode selector of d.h.w. heating	Without ECO, With ECO	-	-	Without ECO
94*	Control of d.h.w. circulating pump	D.h.w. release D.h.w. program	-	-	D.h.w. Program
General					
95	Programming lock	Locked / released	-	-	Released
96*	Clock time master	QAA73, external	-	-	QAA73
97	Summer time start	1.Jan ... 31.Dec	dd.mm	1 day	25.March
98	Summer time end	1.Jan ... 31.Dec	dd.mm	1 day	25.Oct

* These lines are only displayed in OpenTherm Plus mode. Also, the relevant functions must be supported by boiler control.

4.0 Operation

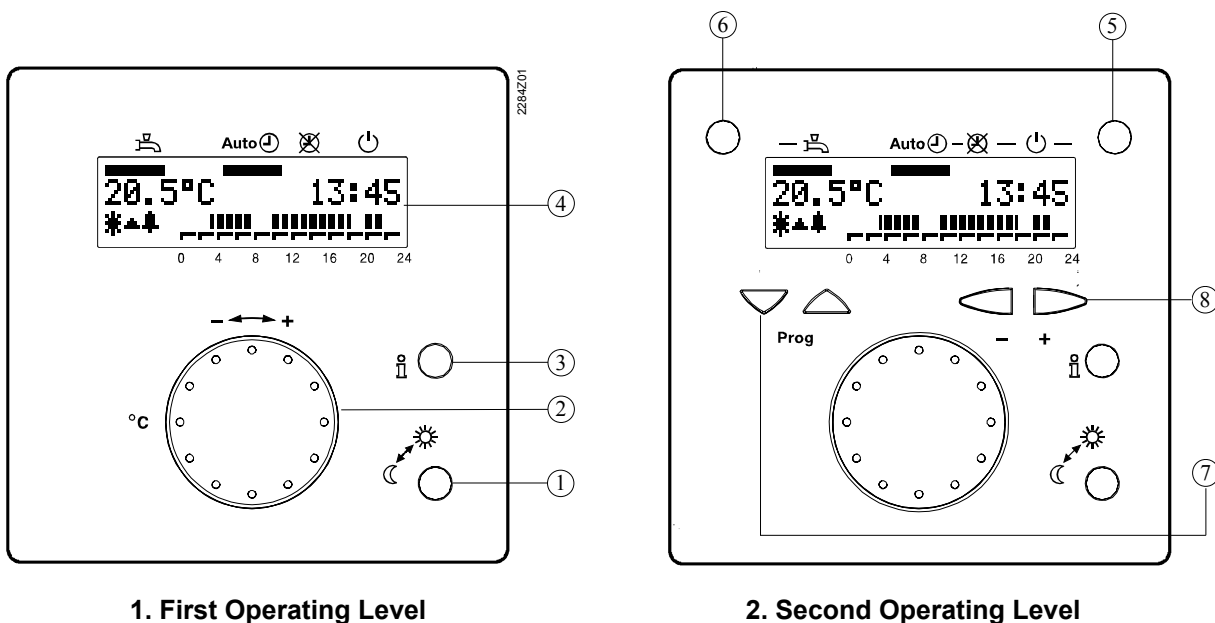

Operating Element

- ① Occupancy button .
- ② Setpoint knob for nominal temperature.
- ③ Info. Button.
- ④ LCD with 2 lines each with 16 characters.
- ⑤ Heating circuit operating mode button and associated symbol
- ⑥ D.h.w. operating mode button with associated symbol
- ⑦ Line selection buttons (up and down)
- ⑧ Setting buttons (plus and minus)

Function

- Changeover of operating level.
- Adjustment of room temperature.
- Change of Info. Display.
- Display of data and operating mode.
- Operating mode changes to;
 - Automatic Operation
 - Continuous Operation
 - Standby
- D.h.w. heating on/off
- Selection of operating line.
- Setting the parameters

Operating elements 1 to 4

Operating elements 5 to 8. Can be accessed only after opening a cover

The room unit has 2 display levels:

- The info level
- The parameter setting / programming level

Displays:

Basic Display:

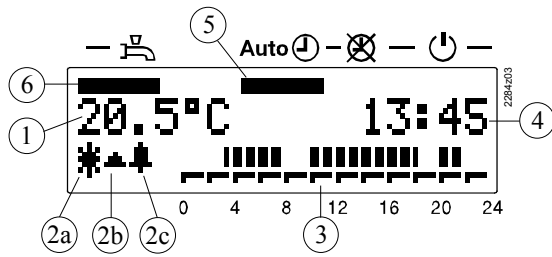

1. Actual value of room temperature.
- 2a. Display of heating circuit operating level:

- Nominal
- Reduced
- Frost Protection

- 2b. Flame status (activated, if flame present).
- 2c. Fault / Service (activated, if fault present / service due).
3. Time pointer.
4. Time of day.
5. Heating circuit operating modes.
6. D.h.w. operating mode.

Display of Operating level, in this case 'Nominal':

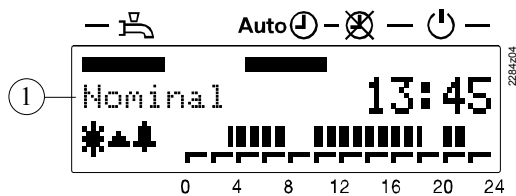

1. Current operating level

Display of Measured Value 'Outside Temperature':

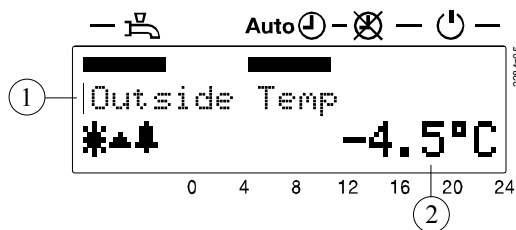

1. Parameter Name
2. Parameter Value

Display of Parameter 'Holidays Start':

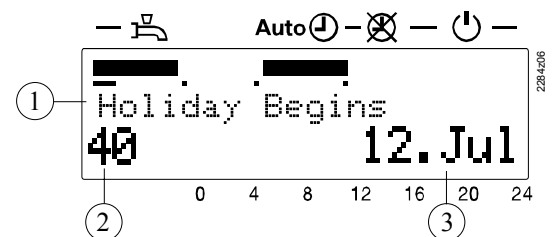

1. Parameter Name
2. Parameter Number
3. Parameter Value

5.0 Operational fault finding

No display on the room unit:

- Is the heating plant's main switch turned on?
- Are the fuses in order?
- Check the wiring

Room unit displays a wrong time of day or a wrong date:

- Set the right time of day, the right date and the year on the room unit if the QAA73.110 is the clock master
- Set the correct time of day and the date on the clock master (if present)

Boiler control does not switch on

- Does boiler control really have to operate?
- Press boiler control's lock-out reset button
- Check the control thermostat (TR) and the manual reset safety limit thermostat (STB)
- Check wiring and fuse of boiler control
- Check the communication link to boiler control

The room temperature does not agree with the required temperature level:

- Does the room temperature setpoint agree with the required temperature level?
- Is the required operating mode indicated?
- Are weekday, time of day and the displayed heating program correct? (Info displays)
- Has the heating curve slope been correctly set?
- Check wiring of outside sensor
- Has the "Nominal room temperature setpoint" with the "Parallel displacement of the heating curve" been calibrated based on the effective room temperature?
- Check boiler control

D.h.w. is not being heated:

- Has the button for d.h.w. heating been pressed?
- Check setpoint of the d.h.w. temperature
- Check d.h.w. function of boiler control

6.0 Technical Data

OpenTherm Interface:

Terminals	2-wire (interchangeable)
Cable length	max. 50m
Cable resistance	max. 2 x 5Ω
Power consumption	30mW (typically)

Safety class	III to EN 60 730 when mounted in compliance with regulations
--------------	---

Degree of Protection	IP 20 to EN 60529
----------------------	-------------------

Contamination	Environment to EN 60730
---------------	-------------------------

Operation	IEC 721-3-3 Class 3K 5
• Temperatures	0..0.50°C
• Humidity	< 85 % r.h.

Transport	IEC 721-3-2 class 2K 3
• Temperatures	-25... 70°C
• Humidity	< 95 % r.h.

Storage	
• Temperatures	-25... 70°C
• Humidity	< 95 % r.h.

CE Conformity

EMC directive	89/336/EEC
-Immunity	EN 50 082-1, EN 50 082-2
-Emmissions	EN 50 081-1, EN 50 081-2
Low Voltage Directive	73/23/EEC
-Electrical Safety	EN 60 730-1, EN 60 730-2-9

Measuring Range	0... 45°C
-----------------	-----------

Back-up of Time Switch	min. 12h
Software Class	A to EN 60 730
Weight	approx 0.17

7.0 Single Heating Zone Installations

Description of system type

All heating circuit pumps and temperature control is achieved via the boiler with the QAA73 room controller. Time clock and climate settings are programmed within the QAA73 room controller as part of the commissioning procedure.

Hardware required

- 1 Boiler incorporating LMU64 boiler management unit.
- 2 Room programmer QAA73. Programmable room unit kit including wiring terminal blocks for boiler LMU wiring connection, part number 563605337.
- 3 External air sensor QAC34. Part number 533901457.

Frost protection

The building is protected for internal temperature using the QAA73 room programmer temperature sensor.

The boiler is internally protected for water temperature using the LMU64 temperature sensors.

Heating pump

The heating pump is designated Q1. This must be connected to the boiler at terminals 'X2-02, Q1 heating circuit pump contactor'. The control signal is a start stop control that must be wired via suitable contactors and hand/auto switches for maintenance purposes.

Flow rate and resistance for the heating pump must be sized in accordance with the flow requirements for the boiler and the resistance requirements of both the boiler and the heating circuit.

Note: The control does not incorporate a facility for switching duty/standby pumps. If required this must

be facilitated externally to these controls.

Room programmer

The single room programmer, QAA73, must be installed in the location most suitable for providing accurate space heating comfort control with the first heating circuit area (circuit using pump Q1). This must be connected to the boiler at terminals 'X10-01, room unit QAA73'.

Wiring should be completed using a 1.5mm² twisted pair shielded cable run separately to any mains cables to prevent electrical interference.

External air sensor

This must be installed on a North facing wall to prevent solar heating of the sensor and away from heat emitting items such as ventilation outlets. Connection is directly to the boiler at terminals 'X10-06, external air sensor QAC34'. Wiring should be completed using a 1.5mm² twisted pair shielded cable, run separately to any mains cables to prevent electrical interference. For further details regarding the sensor specification and fitting requirements refer to appendix A at the rear of this manual.

Features available with this system

- 7 Day time clock with 3 periods each day
- Auto summer/winter time change (BST to GMT)
- Holiday program
- Frost protection for building
- Frost protection for boiler
- Reduced temperature (night setback)
- Optimum start and stop
- Weather compensation
- Summer shutdown
- Fault diagnostics with error code indication
- Programmable lock to prevent tampering after commissioning

Setting the Clock

Parameter	Function	Factory Setting	Required Setting	Notes
1	Time Setting	-	HH:MM	24 Hour clock
2	Date Setting	-	01:01 - 31:12	Day : Month
3	Year	-	2000-2094	Year

Setting Operating Temperatures

Parameter	Function	Factory Setting	Required Setting	Notes
5	Reduced temperature setpoint (night set back)	16°C	As req'd	Must be higher than room frost setting at param. 6 and below room temperature setpoint adjusted with knob.
6	Room frost protection setpoint	10°C	As req'd	Must be lower than reduced temperature setpoint at param. 5 and above 4°C.
46	Summer shutdown	17°C	As req'd 8-30°C	Sets outside temperature at which heating is switched off.

Programming Time Clock and Holidays

Parameter	Function	Factory Setting	Required Setting	Notes
10	Day Selection	-	7 Day block Individual days	Same times every day Different times every day
11	Start time period 1	06:00	As req'd	24 Hour clock
12	Finish time period 1	22:00	As req'd	24 Hour clock
13	Start time period 2	— : —	As req'd	24 Hour clock
14	Finish time period 2	— : —	As req'd	24 Hour clock
15	Start time period 3	— : —	As req'd	24 Hour clock
16	Finish time period 3	— : —	As req'd	24 Hour clock
40	Holiday start date	— : —	As req'd	Set day and month to enable holiday mode
41	Holiday end date	— : —	As req'd	Set day and month to disable holiday mode
42	Holiday operating mode	Frost	As req'd	Sets heating system to reduced temperature or frost protection for holiday duration

Heating Circuit Configuration

Parameter	Function	Factory Setting	Required Setting	Notes
70	Heating curve slope	15	As req'd	Sets weather compensation (see notes below)
71	Minimum setting for flow temperature	8°C	As req'd	For non-condensing boilers recommended setting 60°C
72	Maximum setting for flow temperature	80°C	As req'd	Maximum setting 95°C
73	Parallel displacement of heating curve	0.0	As req'd	Calibration of the room temperatures (see notes below)

Continued on next page...

Continued from previous page...

Parameter	Function	Factory Setting	Required Setting	Notes
74	Type of building construction	1	As req'd	1 = Heavy construction 2 = Light construction
78	Maximum forward shift for optimum start	100 min	As req'd	Recalculates heating start time (see notes below)
79	Maximum forward shift for optimum stop	30 min	As req'd	Recalculates heating finish time (see notes below)

Weather Compensation Curve

The controller adjusts the flow temperature according to outside air temperature. Using a steeper slope provides a higher flow temperature setpoint at low outside temperatures.

Increase slope: The flow temperature will be raised when outside temperature drops.

Decrease slope: The flow temperature will be raised less when the outside temperature drops.

Setting -::: disables weather compensation.

Setting 2.5 to 40 programs desired weather compensation curve

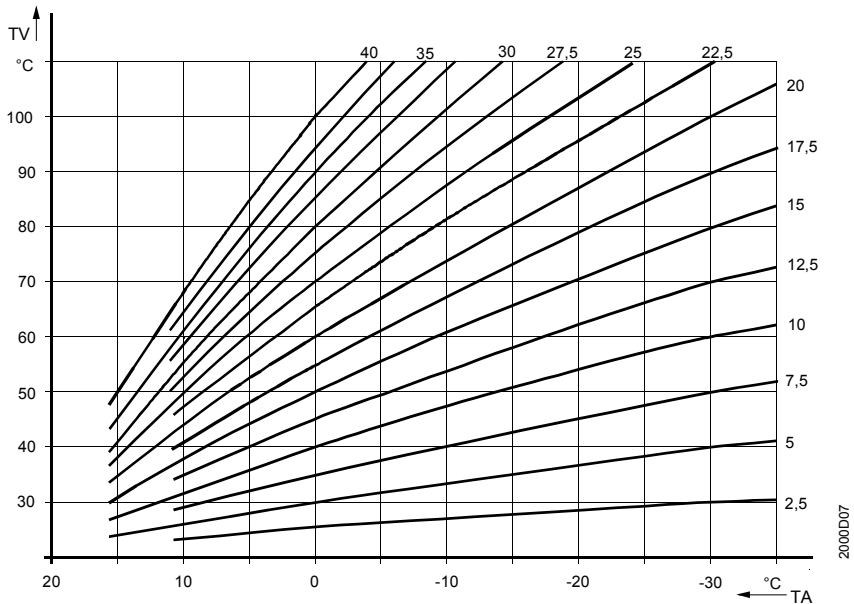

TV = Flow Temperature, TA = Composite Outside Temperature, Factory Setting = 15 i.e. 1.5:1 ratio.

Parallel displacement of the heating curve

Produces a parallel displacement of the heating curve in order to achieve a better match of room temperature setpoint and actual temperature.

e.g. If a nominal room temperature setpoint of 20°C set on the controller always produces a room temperature of 22°C, displace the heating curve downward by 2°

TV = Flow Temperature
TA = Composite Outside Temperature
TRw = Room Temperature Setpoint

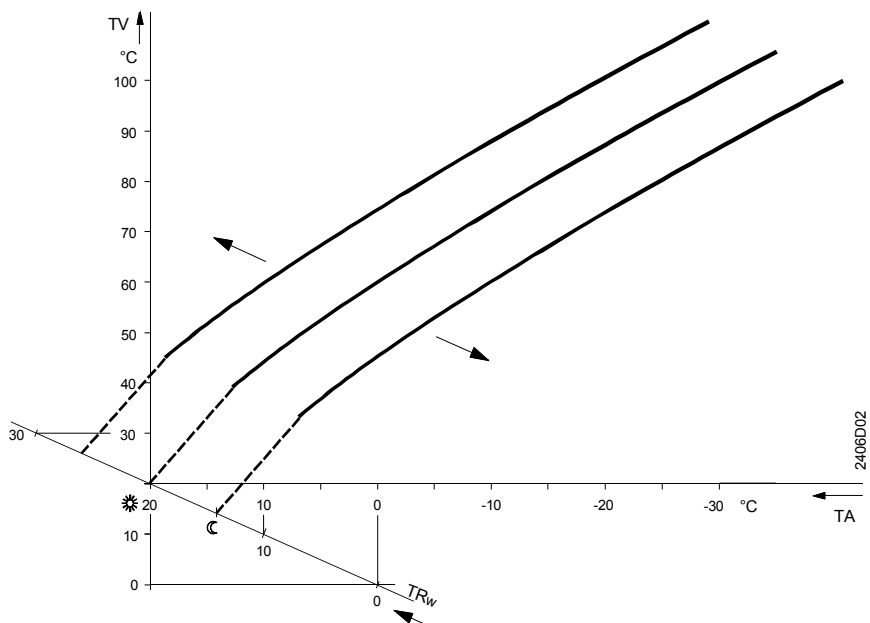

Forward Shift for Optimum Start Control

Recalculates heating circuit start time according to outside air temperature.

- 0 Optimum start control switched off
- 10 to 360 Optimum start control switched on (minutes)

Forward Shift for Optimum Stop Control

Recalculates heating circuit stop time according to outside air temperature

- 0 Optimum stop control switched off
- 10 to 360 Optimum stop control switched on (minutes)

Additional features:

Parameter	Function	Factory Setting	Required Setting	Notes
95	Parameter lock	Released	As req'd	Used to lock or release parameter settings after programming.

Parameter Lock

Particularly useful for installation where the location of the room unit is vulnerable to tampering after commissioning.

When scrolling through the operating lines the display will show a key symbol instead of the actual setting. The settings cannot be changed unless the heating engineer programming mode is entered when the parameter lock is activated.

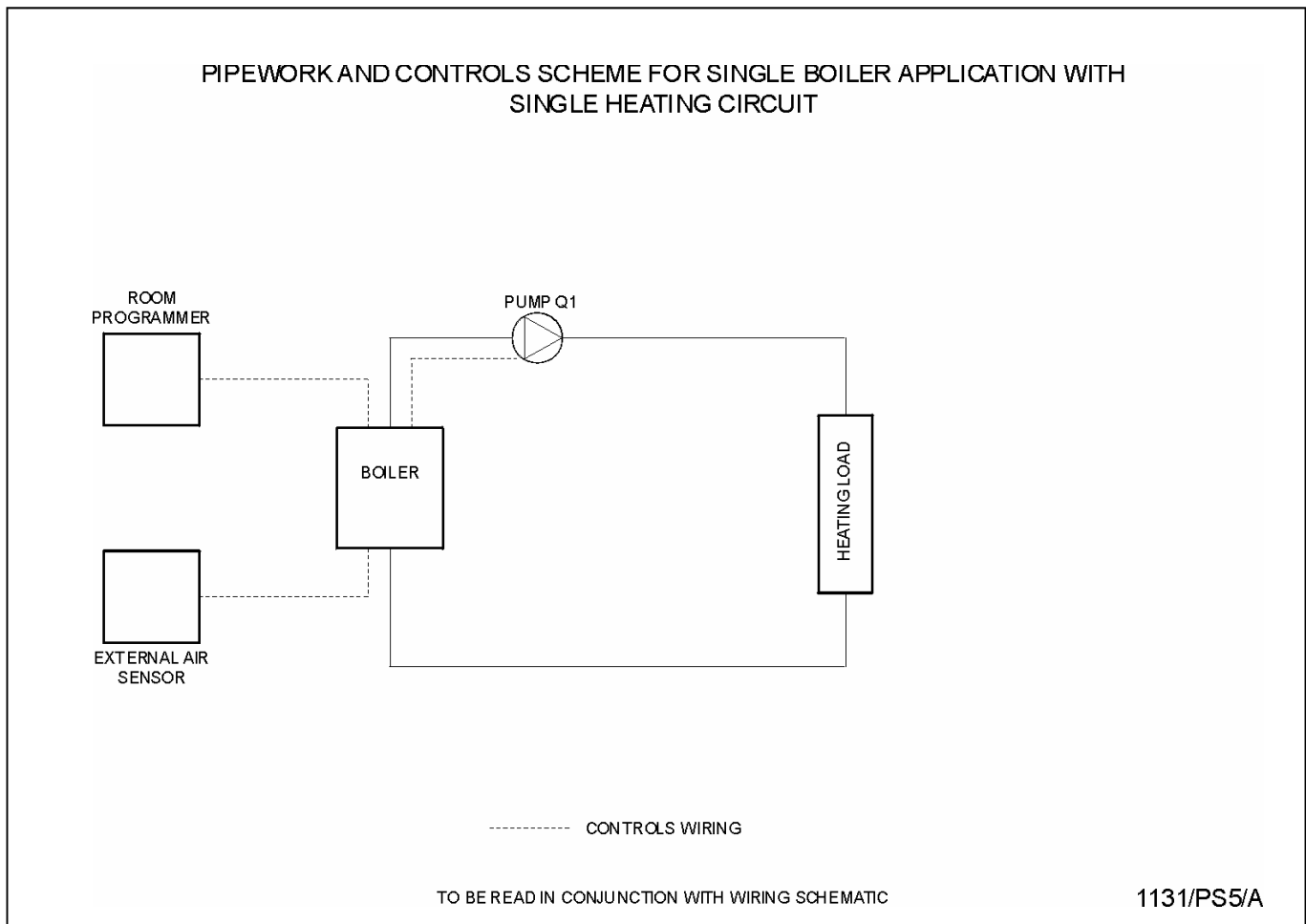

BOILER WIRING SCHEMATIC FOR SINGLE BOILER APPLICATIONS WITH SINGLE HEATING CIRCUIT

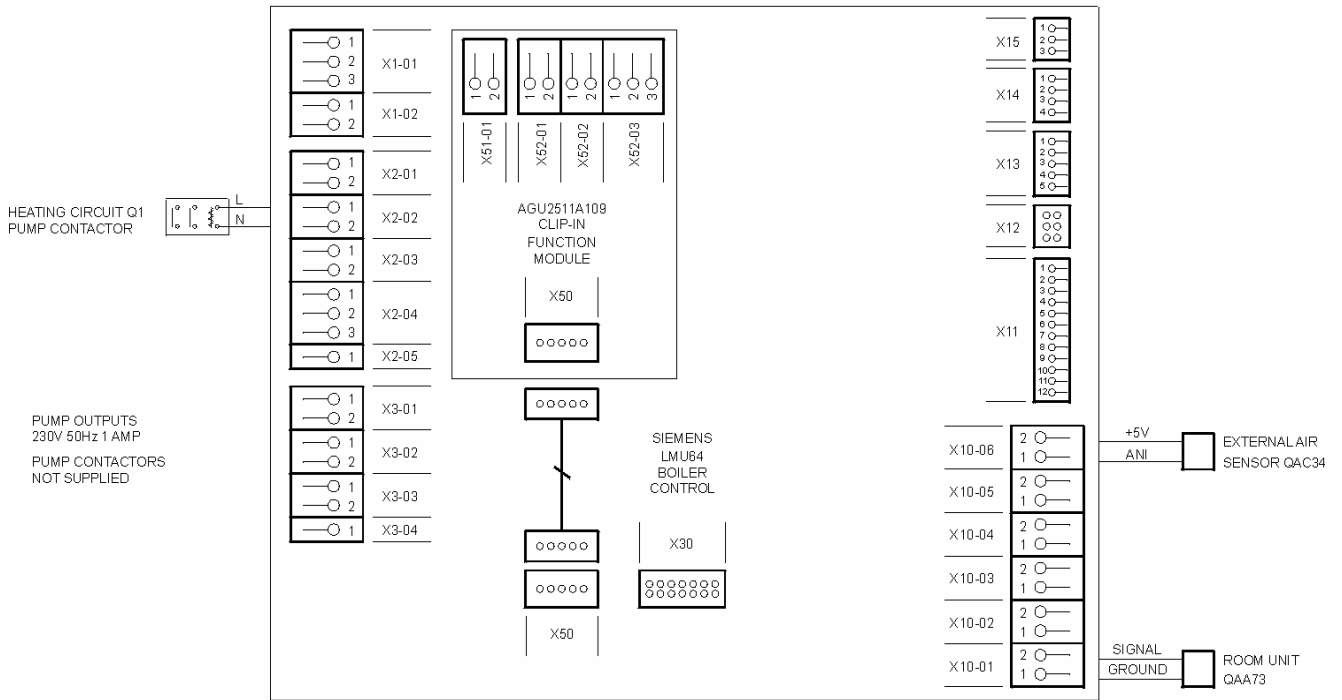

ALL EXISTING WIRING NOT SHOWN FOR CLARITY. REFER TO BOILER INSTALLATION MANUAL FOR BOILER WIRING DETAIL. INTERCONNECTING WIRING NOT SUPPLIED. SIGNAL CABLES MUST BE RUN IN SEPARATE CONDUITS TO MAINS CABLES.

1131/WS5/A

8.0 Single Heating Circuit with Domestic Hot Water

Description of system type

All circuit pumps and temperature control is achieved via the boiler with the QAA73 room controller. Time clock and climate settings are programmed within the QAA73 room controller as part of the commissioning procedure.

The boiler controller, LMU64, will set the primary temperature according to the highest heat requirement, ie, if the D.H.W. cylinder requires a higher temperature than the heating circuit the primary temperature will be set to this. During this period the heating circuit pump will be switched off to prevent overheating of the space.

Hardware required

- 1 Boiler incorporating LMU64 boiler management unit.
- 2 Room programmer QAA73. Programmable room unit kit including wiring terminal blocks for boiler LMU wiring connection, part number 563605337.
- 3 External air sensor QAC34. Part number 533901457.
- 4 D.H.W. Cylinder sensor QAZ21. Sensor kit including wiring terminal blocks for boiler LMU wiring connection and immersion pocket, part number 563605338.

Frost protection

The building is protected for internal temperature using the QAA73 room programmer temperature sensor.

The boiler is internally protected for water temperature using the LMU64 temperature sensors. Also the D.H.W. cylinder is protected via the signal received from the cylinder sensor. Both boiler and hot water cylinder frost protection settings are pre-programmed in the boiler controls, not the QAA73 programmable room unit.

Primary circuit pump

The primary circuit pump is designated Q8. this must be connected to the boiler at terminals 'X2-03, Q8 primary circuit pump contactor'. The control signal is a start stop control that must be wired via suitable contactors and hand/auto switches for maintenance purposes.

Flow rate and resistance for the primary pump must be sized in accordance with the flow requirements for the boiler and the resistance requirements of both the boiler and the primary circuit.

Note: The control does not incorporate a facility for switching duty/standby pumps. If required this must be facilitated externally to these controls.

Heating circuit pump

The heating pump is designated Q1. This must be connected to the boiler at terminals 'X2-02, Q1 heating circuit pump contactor'. The control signal is a start stop control that must be wired via suitable contactors and hand/auto switches for maintenance purposes.

Flow rate and resistance for the heating pump must be sized in accordance with the flow requirements for the heating circuit and the resistance requirements of the heating circuit.

Note: The control does not incorporate a facility for switching duty/standby pumps. If required this must be facilitated externally to these controls.

D.H.W. Circuit pump

The D.H.W. circuit pump is designated Q3. This must be connected to the boiler at terminals 'X2-04, Q3 DHW cylinder pump contactor'. The control signal is a start stop control that must be wired via suitable contactors and hand/auto switches for maintenance purposes.

Flow rate and resistance for the D.H.W. circuit pump must be sized in accordance with the flow requirements for the cylinder and the resistance requirements of the cylinder and pipework circuit.

Note: The control does not incorporate a facility for switching duty/standby pumps. If required this must be facilitated externally to these controls.

Room programmer

The single room programmer, QAA73, must be installed in the location most suitable for providing accurate space heating comfort control with the first heating circuit area (circuit using pump Q1). This must be connected to the boiler at terminals 'X10-01, room unit QAA73'.

Wiring should be completed using a 1.5mm² twisted pair shielded cable run separately to any mains cables to prevent electrical interference.

External air sensor

This must be installed on a North facing wall to prevent solar heating of the sensor and away from heat emitting items such as ventilation outlets. Connection is directly to the boiler at terminals 'X10-06, external air sensor QAC34'. Wiring should be completed using a 1.5mm² twisted pair shielded cable, run separately to any mains cables to prevent

electrical interference. For further details regarding the sensor specification and fitting requirements refer to appendix A at the rear of this manual.

D.H.W. Cylinder sensor

This should be fitted to the cylinder using the pocket provided on the cylinder to ensure accurate temperature detection. Connection is directly to the boiler at terminals' X10-05, D.H.W. cylinder sensor QAL36'. Wiring should be completed using a 1.5mm² twisted pair shielded cable, run separately to any mains cables to prevent electrical interference.

Note: The cable supplied with the sensor may require extending.

Features available with this system

- 7 Day time clock with 3 periods each day for heating circuit
- 7 Day time clock with 3 periods each day for hot water circuit
- Auto summer/winter time change (BST to GMT)
- Holiday program
- Frost protection for building
- Frost protection for boiler
- Frost protection for hot water cylinder
- Reduced temperature (night setback)
- Reduced hot water storage temperature (night setback)
- Optimum start and stop
- Weather compensation
- Summer shutdown
- Fault diagnostics with error code indication
- Programmable lock to prevent tampering after commissioning

Setting the Clock

Parameter	Function	Factory Setting	Required Setting	Notes
1	Time Setting	-	HH:MM	24 Hour clock
2	Date Setting	-	01:01 - 31:12	Day : Month
3	Year	-	2000-2094	Year

Setting Temperatures

Parameter	Function	Factory Setting	Required Setting	Notes
5	Reduced temperature setpoint (night set back)	16°C	As req'd	Must be higher than room frost setting at param. 6 and below room temperature setpoint adjusted with knob.
6	Room frost protection setpoint	10°C	As req'd	Must be lower than reduced temperature setpoint at param. 5 and above 4°C.
7	D.h.w. temperature setpoint	55°C	As req'd	Recommended minimum setting 60°C
46	Summer shutdown	17°C	As req'd 8-30°C	Sets outside temperature at which heating is switched off.

Programming Time Clock - Heating Circuit

Parameter	Function	Factory Setting	Required Setting	Notes
10	Day Selection	-	7 Day block Individual days	Same times every day Different times every day
11	Start time period 1	06:00	As req'd	24 Hour clock
12	Finish time period 1	22:00	As req'd	24 Hour clock

Continued on next page...

Continued from previous page...

Parameter	Function	Factory Setting	Required Setting	Notes
13	Start time period 2	— : —	As req'd	24 Hour clock
14	Finish time period 2	— : —	As req'd	24 Hour clock
15	Start time period 3	— : —	As req'd	24 Hour clock
16	Finish time period 3	— : —	As req'd	24 Hour clock

Programming Time Clock - Hot Water Circuit

Parameter	Function	Factory Setting	Required Setting	Notes
30	Day Selection	-	7 Day Block Individual Days	Same times every day Different times each day
31	Start time period 1	06:00	As req'd	24 Hour clock
32	Finish time period 1	22:00	As req'd	24 Hour clock
33	Start time period 2	— : —	As req'd	24 Hour clock
34	Finish time period 2	— : —	As req'd	24 Hour clock
35	Start time period 3	— : —	As req'd	24 Hour clock
36	Finish time period 3	— : —	As req'd	24 Hour clock

Programming Holiday Period

40	Holiday start date	— : —	As req'd	Set day and month to enable holiday mode
41	Holiday end date	— : —	As req'd	Set day and month to disable holiday mode
42	Holiday operating mode	Frost	As req'd	Sets heating system to reduced temperature or frost protection for holiday duration

Heating Circuit Configuration

70	Heating curve slope	15	As req'd	Sets weather compensation (see notes below)
71	Minimum setting for flow temperature	8°C	As req'd	For non-condensing boilers recommended setting 60°C
72	Maximum setting for flow temperature	80°C	As req'd	Maximum setting 95°C
73	Parallel displacement of heating curve	0.0	As req'd	Calibration of the room temperatures (see notes below)

Continued from previous page...

Parameter	Function	Factory Setting	Required Setting	Notes
74	Type of building construction	1	As req'd	1 = Heavy construction 2 = Light construction
78	Maximum forward shift for optimum start	100 min	As req'd	Recalculates heating start time (see notes below)
79	Maximum forward shift for optimum stop	30 min	As req'd	Recalculates heating finish time (see notes below)

D.h.w. Circuit Configuration

Parameter	Function	Factory Setting	Required Setting	Notes
90	Reduced temperature setpoint d.h.w. circuit (night set back)	40°C	As req'd	Must be below hot water temperature setting at param. 7 and above 8°C
91	Release of D.h.w. heating	TSP HC - 1H	TSP d.h.w.	Sets d.h.w availability according to time clock settings

Weather Compensation Curve

The controller adjusts the flow temperature according to outside air temperature. Using a steeper slope provides a higher flow temperature setpoint at low outside temperatures.

Increase slope: The flow temperature will be raised when outside temperature drops.

Decrease slope: The flow temperature will be raised less when the outside temperature drops.

Setting -:-- disables weather compensation.

Setting 2.5 to 40 programs desired weather compensation curve

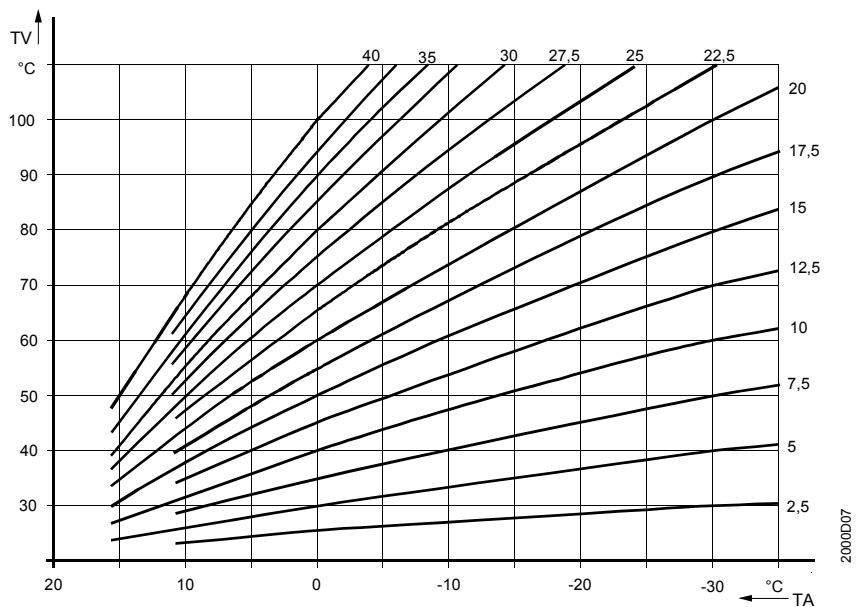

TV = Flow Temperature, TA = Composite Outside Temperature, Factory Setting = 15 i.e. 1.5:1 ratio.

Parallel displacement of the heating curve

Produces a parallel displacement of the heating curve in order to achieve a better match of room temperature setpoint and actual temperature.

e.g. If a nominal room temperature setpoint of 20°C set on the controller always produces a room temperature of 22°C, displace the heating curve downward by 2°

TV = Flow Temperature
 TA = Composite Outside Temperature
 TRw = Room Temperature Setpoint

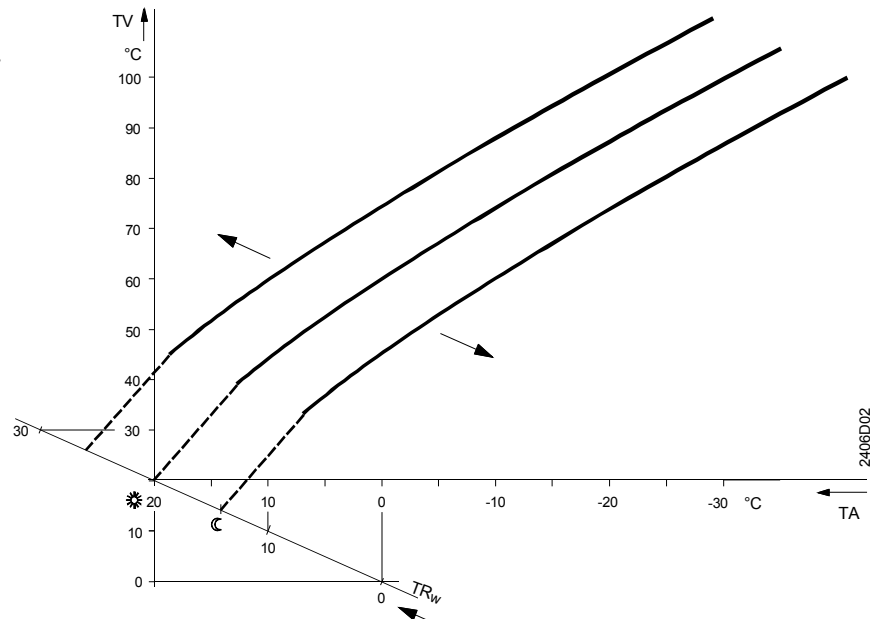

Forward Shift for Optimum Start Control

Recalculates heating circuit start time according to outside air temperature.

- 0 Optimum start control switched off
- 10 to 360 Optimum start control switched on (minutes)

Forward Shift for Optimum Stop Control

Recalculates heating circuit stop time according to outside air temperature

- 0 Optimum stop control switched off
- 10 to 360 Optimum stop control switched on (minutes)

Additional features:

Parameter	Function	Factory Setting	Required Setting	Notes
95	Parameter lock	Released	As req'd	Used to lock or release parameter settings after programming.

Parameter Lock

Particularly useful for installation where the location of the room unit is vulnerable to tampering after commissioning.

When scrolling through the operating lines the display will show a key symbol instead of the actual setting. The settings cannot be changed unless the heating engineer programming mode is entered when the parameter lock is activated.

PIPEWORK AND CONTROLS SCHEME FOR SINGLE BOILER APPLICATION WITH SINGLE HEATING CIRCUIT AND DHW CYLINDER

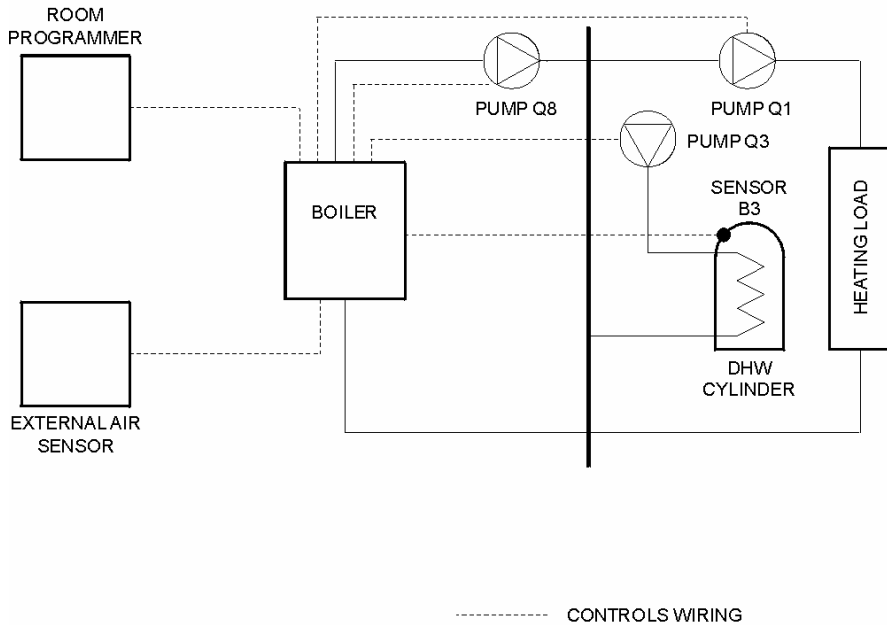

TO BE READ IN CONJUNCTION WITH WIRING SCHEMATIC

1131/PS6/A

BOILER WIRING SCHEMATIC FOR SINGLE BOILER APPLICATIONS WITH SINGLE HEATING CIRCUIT AND DOMESTIC HOT WATER CYLINDER

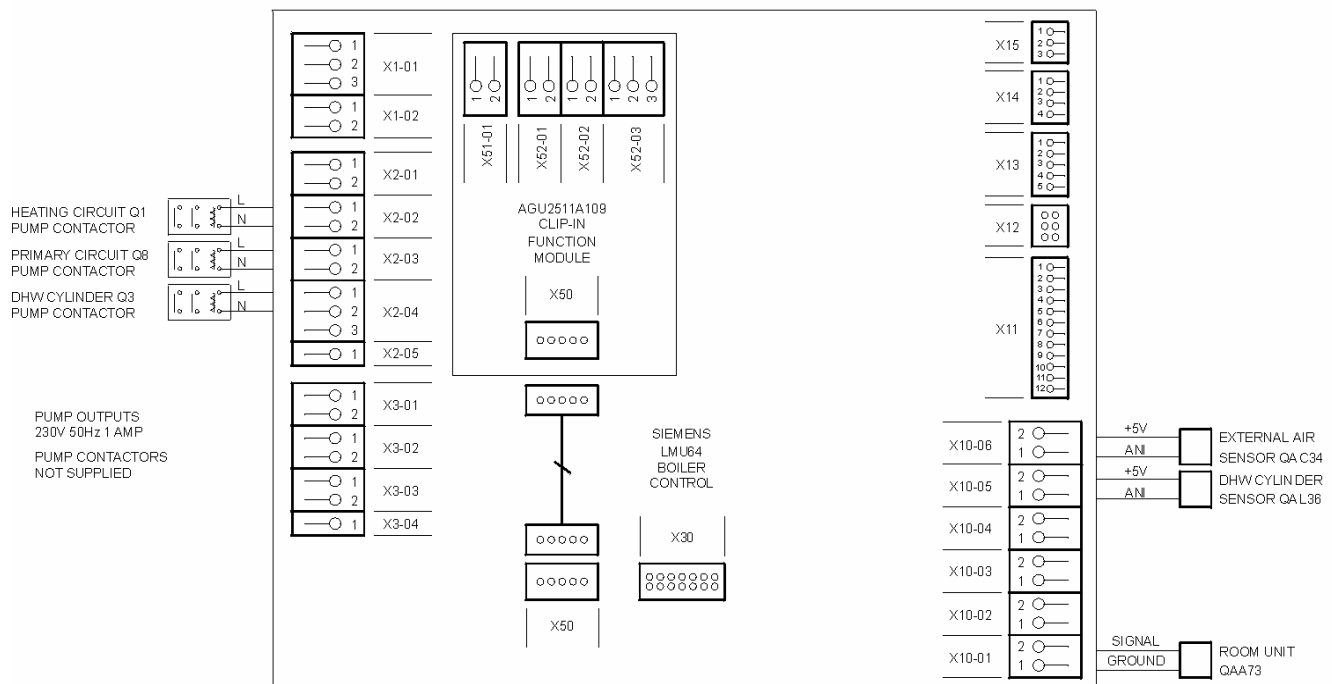

ALL EXISTING WIRING NOT SHOWN FOR CLARITY. REFER TO BOILER INSTALLATION MANUAL FOR BOILER WIRING DETAIL. INTERCONNECTING WIRING NOT SUPPLIED. SIGNAL CABLES MUST BE RUN IN SEPARATE CONDUITS TO MAINS CABLES.

1131/WS6/A

9.0 Twin Heating Circuits with Domestic Hot Water

Description of system type

All circuit pumps and temperature control is achieved via the boiler with the QAA73 room controller. Time clock and climate settings are programmed within the QAA73 room controller as part of the commissioning procedure.

The boiler controller, LMU64, will set the primary temperature according to the highest heat requirement, ie, if the D.H.W. cylinder requires a higher temperature than the heating circuits the primary temperature will be set to this. During this period the heating circuit pumps will be switched off to prevent overheating of the space.

Hardware required

1. Boiler incorporating LMU64 boiler management unit.
2. Room programmer QAA73. Programmable room unit kit including wiring terminal blocks for boiler LMU wiring connection, part number 563605337.
3. External air sensor QAC34. Part number 533901457.
4. D.H.W. Cylinder sensor QAL36. Sensor kit including wiring terminal blocks for boiler LMU wiring connection and immersion pocket, part number 563605338.
5. Second heating circuit clip-in relay AGU2.500A109. Relay kit including wiring terminal blocks for boiler LMU wiring connection, zone water temperature sensor QAL36 and immersion pocket, part number 563605339.

Fitting second heating circuit clip in relay kit AGU2.500A109

The clip-in relay is required to provide an output signal to enable the second heating circuit pump.

This clip-in relay must be fitted to the boiler control unit LMU64. In the open space alongside the standard relay the new clip-in must be firmly pushed into its mounting position.

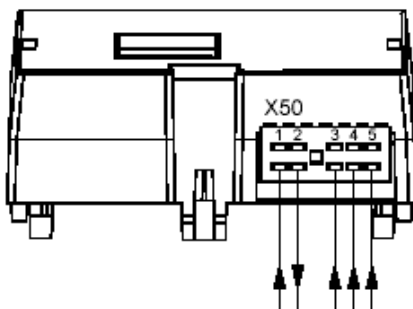

Connect the clip-in relay using the ribbon cable supplied to terminal connection X40 at the boiler LMU64 controller.

Power for the clip-in relay is supplied via the existing clip-in relay to the left of the second heating circuit clip-in relay. Using the 2 core cable supplied with the kit connect terminal block X52-01 of the second heating circuit relay to terminal block X52-01 of the existing relay. Ensure the Live supply is connected to terminal 1 and Neutral to terminal 2.

Wiring output to pump contactor (not supplied) from terminals 1 & 2 (L & N) block X52-02 of the clip-in relay.

Wiring output to the mixing valve (not supplied) from terminals 1,2&3 block X52-03 of the clip-in relay.

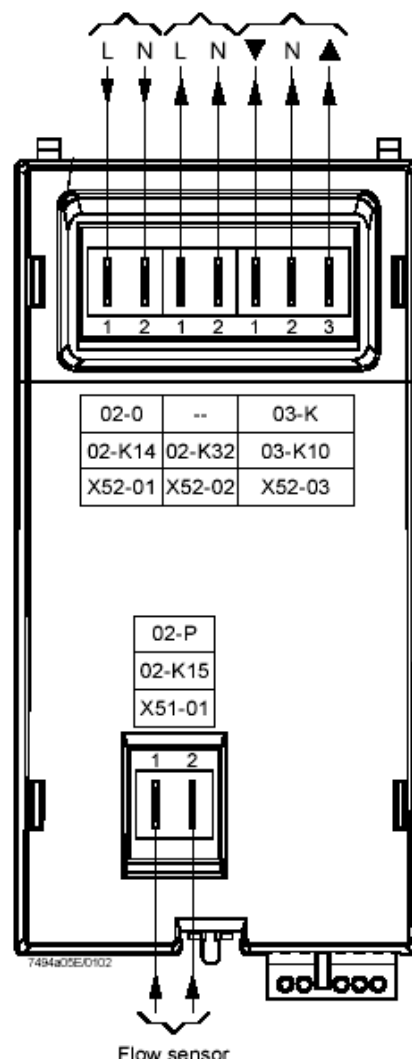

Connect the flow sensor, QAL36, supplied with the kit, using a twisted pair shielded cable, to terminals X51-01 on the second heating circuit clip-in relay.

Frost protection

The building is protected for internal temperature using the QAA73 room programmer temperature sensor.

The boiler is internally protected for water temperature using the LMU64 temperature sensors. Also the D.H.W. cylinder is protected via the signal received from the cylinder sensor. Both boiler and hot water cylinder frost protection settings are pre-programmed in the boiler controls, not the QAA73 programmable room unit.

Primary circuit pump

The primary circuit pump is designated Q8. This must be connected to the boiler at terminals 'X2-03, Q8 primary circuit pump contactor'. The control signal is a start stop control that must be wired via suitable contactors and hand/auto switches for maintenance purposes.

Flow rate and resistance for the primary pump must be sized in accordance with the flow requirements for the boiler and the resistance requirements of both the boiler and the primary circuit.

Note: The control does not incorporate a facility for switching duty/standby pumps. If required this must be facilitated externally to these controls.

Heating circuit pump

The heating pump is designated Q1. This must be connected to the boiler at terminals 'X2-02, Q1 heating circuit pump contactor'. The control signal is a start stop control that must be wired via suitable contactors and hand/auto switches for maintenance purposes.

Flow rate and resistance for the heating pump must be sized in accordance with the flow requirements for the heating circuit and the resistance requirements of the heating circuit.

Note: The control does not incorporate a facility for switching duty/standby pumps. If required this must be facilitated externally to these controls.

Second heating circuit pump

The second heating circuit pump is designated Q2. This must be connected to the boiler using the clip-in relay terminals 'X52-02, Q2 2nd circuit pump contactor'.

Flow rate and resistance for the second heating circuit pump must be sized in accordance with the flow requirements for the second heating circuit and the resistance requirements of the second heating circuit.

Note: The control does not incorporate a facility for switching duty/standby pumps. If required this must be facilitated externally to these controls.

D.H.W. Circuit pump

The D.H.W. circuit pump is designated Q3. This must be connected to the boiler at terminals 'X2-04, Q3 DHW cylinder pump contactor'. The control signal is a start stop control that must be wired via suitable contactors and hand/auto switches for maintenance purposes.

Flow rate and resistance for the D.H.W. circuit pump must be sized in accordance with the flow requirements for the cylinder and the resistance requirements of the cylinder and pipework circuit.

Note: The control does not incorporate a facility for switching duty/standby pumps. If required this must be facilitated externally to these controls.

Room programmer

The single room programmer, QAA73, must be installed in the location most suitable for providing accurate space heating comfort control with the first heating circuit area (circuit using pump Q1). This must be connected to the boiler at terminals 'X10-01, room unit QAA73'.

Wiring should be completed using a 1.5mm² twisted pair shielded cable run separately to any mains cables to prevent electrical interference.

External air sensor

This must be installed on a North facing wall to prevent solar heating of the sensor and away from heat emitting items such as ventilation outlets. Connection is directly to the boiler at terminals 'X10-06, external air sensor QAC34'. Wiring should be completed using a 1.5mm² twisted pair shielded cable, run separately to any mains cables to prevent electrical interference. For further details regarding the sensor specification and fitting requirements refer to appendix A at the rear of this manual.

D.H.W. Cylinder sensor

This should be fitted to the cylinder using the pocket provided on the cylinder to ensure accurate temperature detection. Connection is directly to the boiler at terminals 'X10-05, D.H.W. cylinder sensor QAL36'. Wiring should be completed using a 1.5mm² twisted pair shielded cable, run separately to any mains cables to prevent electrical interference.

Note: The cable supplied with the sensor may require extending.

Features available with this system

- 7 Day time clock with 3 periods each day for heating circuit
- 7 Day time clock with 3 periods each day for hot water circuit
- Auto summer/winter time change (BST to GMT)
- Holiday program
- Frost protection for building
- Frost protection for boiler
- Frost protection for hot water cylinder
- Reduced temperature (night setback)
- Reduced hot water storage temperature (night setback)
- Optimum start and stop
- Weather compensation
- Summer shutdown
- Fault diagnostics with error code indication
- Programmable lock to prevent tampering after commissioning

Setting the Clock

Parameter	Function	Factory Setting	Required Setting	Notes
1	Time Setting	-	HH:MM	24 Hour clock
2	Date Setting	-	01:01 - 31:12	Day : Month
3	Year	-	2000-2094	Year

Setting Temperatures

Parameter	Function	Factory Setting	Required Setting	Notes
5	Reduced temperature setpoint (night set back)	16°C	As req'd	Must be higher than room frost setting at param. 6 and below room temperature setpoint adjusted with knob.
6	Room frost protection setpoint	10°C	As req'd	Must be lower than reduced temperature setpoint at param. 5 and above 4°C.
7	D.h.w. temperature setpoint	55°C	As req'd	Recommended minimum setting 60°C
46	Summer shutdown	17°C	As req'd 8-30°C	Sets outside temperature at which heating is switched off.

Programming Time Clock - Heating Circuit

Parameter	Function	Factory Setting	Required Setting	Notes
10	Day Selection	-	7 Day block Individual days	Same times every day Different times every day
11	Start time period 1	06:00	As req'd	24 Hour clock
12	Finish time period 1	22:00	As req'd	24 Hour clock
13	Start time period 2	— : —	As req'd	24 Hour clock
14	Finish time period 2	— : —	As req'd	24 Hour clock
15	Start time period 3	— : —	As req'd	24 Hour clock
16	Finish time period 3	— : —	As req'd	24 Hour clock

Programming Time Clock - Second Heating Circuit

Parameter	Function	Factory Setting	Required Setting	Notes
20	Day Selection	-	7 Day block Individual days	Same times every day Different times every day
21	Start time period 1	06:00	As req'd	24 Hour clock
22	Finish time period 1	22:00	As req'd	24 Hour clock
23	Start time period 2	— : —	As req'd	24 Hour clock
24	Finish time period 2	— : —	As req'd	24 Hour clock
25	Start time period 3	— : —	As req'd	24 Hour clock
26	Finish time period 3	— : —	As req'd	24 Hour clock

Programming Time Clock - Hot Water Circuit

Parameter	Function	Factory Setting	Required Setting	Notes
30	Day Selection	-	7 Day block Individual days	Same times every day Different times every day
31	Start time period 1	06:00	As req'd	24 Hour clock
32	Finish time period 1	22:00	As req'd	24 Hour clock
33	Start time period 2	— : —	As req'd	24 Hour clock
34	Finish time period 2	— : —	As req'd	24 Hour clock
35	Start time period 3	— : —	As req'd	24 Hour clock
36	Finish time period 3	— : —	As req'd	24 Hour clock

Programming Holiday Period

40	Holiday start date	— : —	As req'd	Set day and month to enable holiday mode
41	Holiday end date	— : —	As req'd	Set day and month to disable holiday mode
42	Holiday operating mode	Frost	As req'd	Sets heating system to reduced temperature or frost protection for holiday duration

Continued on next page...

Heating Circuit Configuration Circuit 1

Parameter	Function	Factory Setting	Required Setting	Notes
70	Heating curve slope circuit 1	15	As req'd	Sets weather compensation (see notes below)
71	Minimum setting for flow temperature circuit 1	8°C	As req'd	For non-condensing boilers recommended setting 60°C
72	Maximum setting for flow temperature circuit 1	80°C	As req'd	Maximum setting 95°C
73	Parallel displacement of heating curve circuit 1	0.0	As req'd	Calibration of the room temperatures (see notes below)
74	Type of building construction	1	As req'd	1 = Heavy construction 2 = Light construction
78	Maximum forward shift for optimum start	100 min	As req'd	Recalculates heating start time (see notes below)
79	Maximum forward shift for optimum stop	30 min	As req'd	Recalculates heating finish time (see notes below)

Heating Circuit Configuration Circuit 2

Parameter	Function	Factory Setting	Required Setting	Notes
80	Heating curve slope circuit 2	15	As req'd	Sets weather compensation (see notes below)
81	Minimum setting for flow temperature circuit 2	8°C	As req'd	For non-condensing boilers recommended setting 60°C
82	Maximum setting for flow temperature circuit 2	80°C	As req'd	Maximum setting 95°C
83	Parallel displacement of heating curve circuit 2	0.0	As req'd	Calibration of the room temperatures (see notes below)

D.h.w. Circuit Configuration

Parameter	Function	Factory Setting	Required Setting	Notes
90	Reduced temperature setpoint d.h.w. circuit (night set back)	40°C	As req'd	Must be below hot water temperature setting at param. 7 and above 8°C
91	Release of D.h.w. heating	TSP HC - 1H	TSP d.h.w.	Sets d.h.w availability according to time clock settings

Weather Compensation Curve

The controller adjusts the flow temperature according to outside air temperature. Using a steeper slope provides a higher flow temperature setpoint at low outside temperatures.

Increase slope: The flow temperature will be raised when outside temperature drops.

Decrease slope: The flow temperature will be raised less when the outside temperature drops.

Setting -::: disables weather compensation.

Setting 2.5 to 40 programs desired weather compensation curve

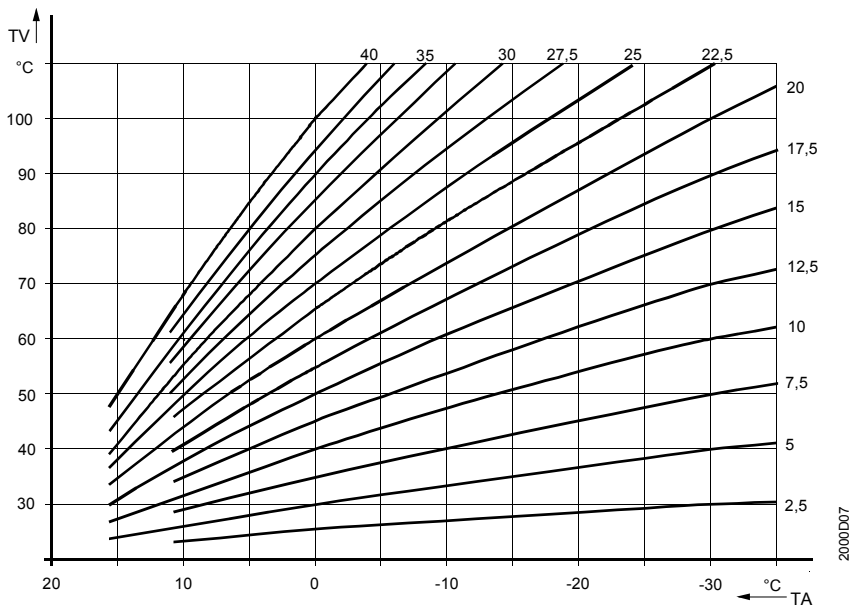

TV = Flow Temperature, TA = Composite Outside Temperature, Factory Setting = 15 i.e. 1.5:1 ratio. For under-floor heating circuits a maximum curve setting of 8 is recommended to prevent overheating.

Parallel displacement of the heating curve

Produces a parallel displacement of the heating curve in order to achieve a better match of room temperature setpoint and actual temperature.

e.g. If a nominal room temperature setpoint of 20°C set on the controller always produces a room temperature of 22°C, displace the heating curve downward by 2°

TV = Flow Temperature
 TA = Composite Outside Temperature
 TRw = Room Temperature Setpoint

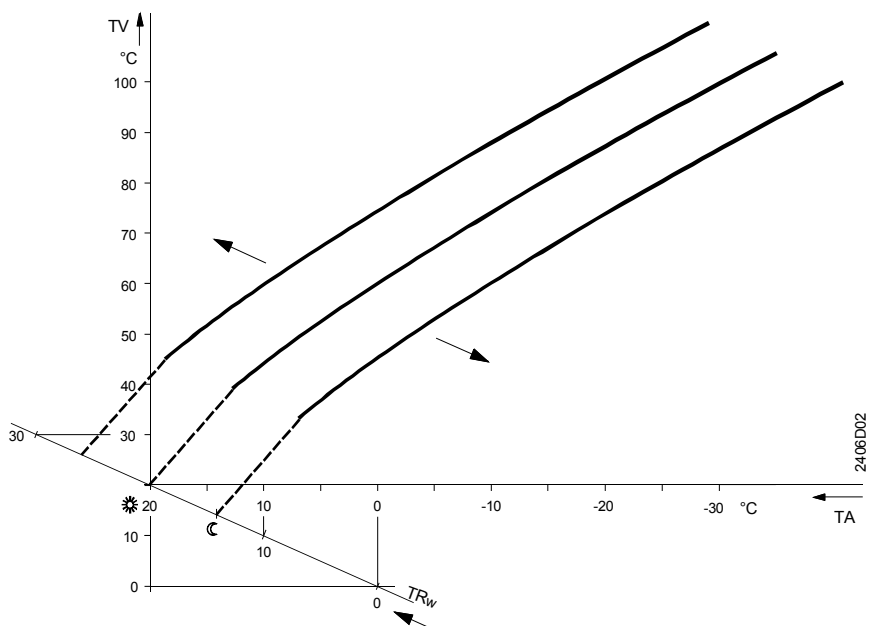

Forward Shift for Optimum Start Control

Recalculates heating circuit start time according to outside air temperature.
 0 Optimum start control switched off
 10 to 360 Optimum start control switched on (minutes)

Forward Shift for Optimum Stop Control

Recalculates heating circuit stop time according to outside air temperature
 0 Optimum stop control switched off
 10 to 360 Optimum stop control switched on (minutes)

Additional Features

Parameter	Function	Factory Setting	Required Setting	Notes
95	Parameter lock	Released	As req'd	Used to lock or release parameter settings after programming.

Parameter Lock

Particularly useful for installation where the location of the room unit is vulnerable to tampering after commissioning.

When scrolling through the operating lines the display will show a key symbol instead of the actual setting. The settings cannot be changed unless the heating engineer programming mode is entered when the parameter lock is activated.

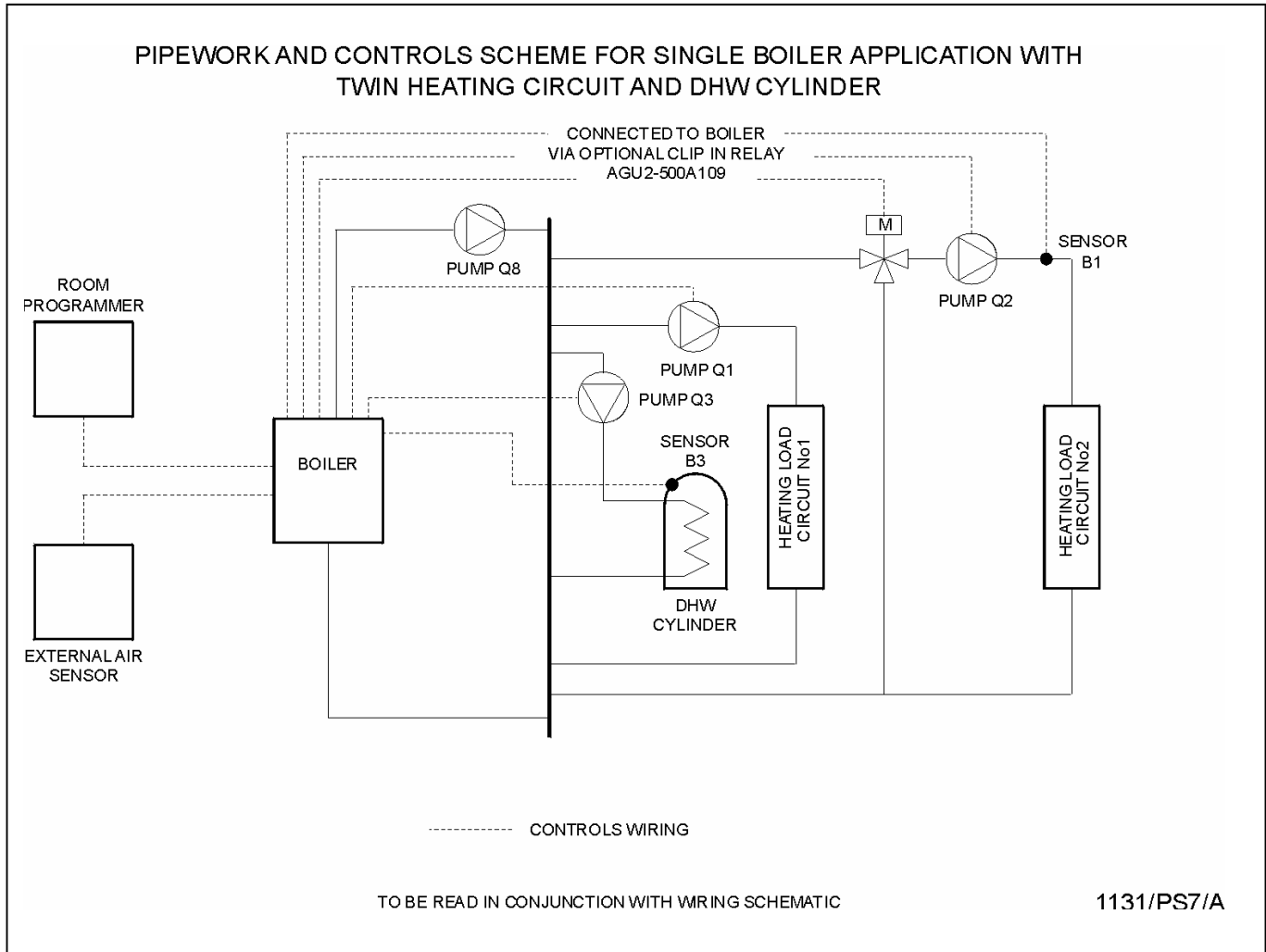

BOILER WIRING SCHEMATIC FOR SINGLE BOILER APPLICATIONS WITH TWIN HEATING CIRCUIT AND DOMESTIC HOT WATER CYLINDER

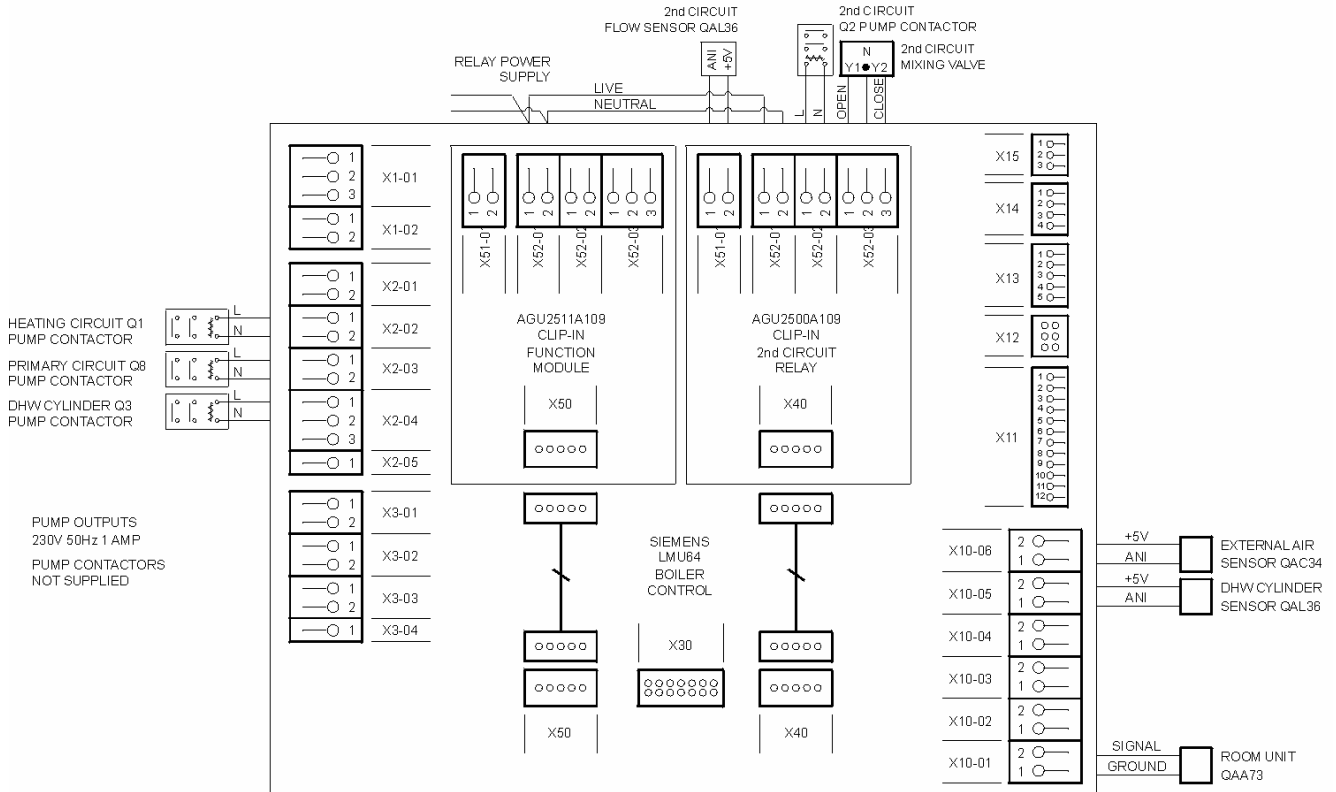

ALL EXISTING WIRING NOT SHOWN FOR CLARITY. REFER TO BOILER INSTALLATION MANUAL FOR BOILER WIRING DETAIL. INTERCONNECTING WIRING NOT SUPPLIED. SIGNAL CABLES MUST BE RUN IN SEPARATE CONDUITS TO MAINS CABLES.

1131/WS7/A

APPENDIX A: Sensors

External Air Sensor QAC34

The outside sensor consists of plastic housing with a removable cover. The sensing element is embedded in synthetic resin. The connection terminals are accessible after removal of the cover. To introduce the cable through the wall, a grommet, cable gland or sealing compound is required (also refer to illustration below). For wall mounting, a cable entry gland Pg 11 can be fitted to the bottom of the housing.

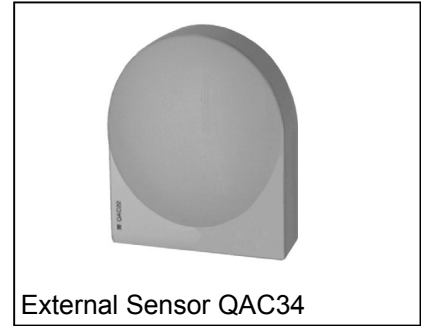

Type Ref	Sensing Element	Range (°C)	Tolerance (K*)	Time Constant (min)	Weight (g)	Copper Cable (mm ²) /Cable Dia (mm)	Perm. Cable Length (m)
QAC34/101	NTC1000Ω at 20°C	-50... 70	± 1	12	73	1.5 / 7.2	120

* QAC34/101 at -10 - +20C. The sensing element is an NTC resistor with a resistance of 1000Ω at 25°C. The resistance drops at about 4% per Kelvin.

Mounting Position:

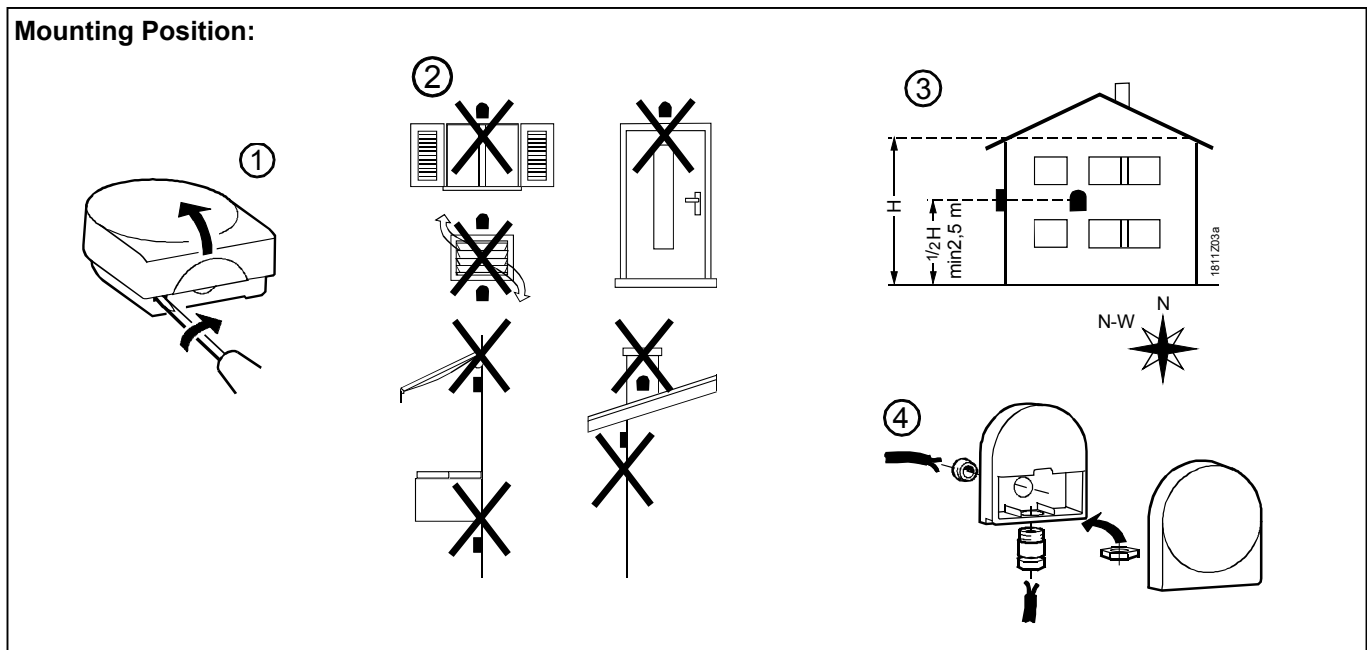

Dimensions:

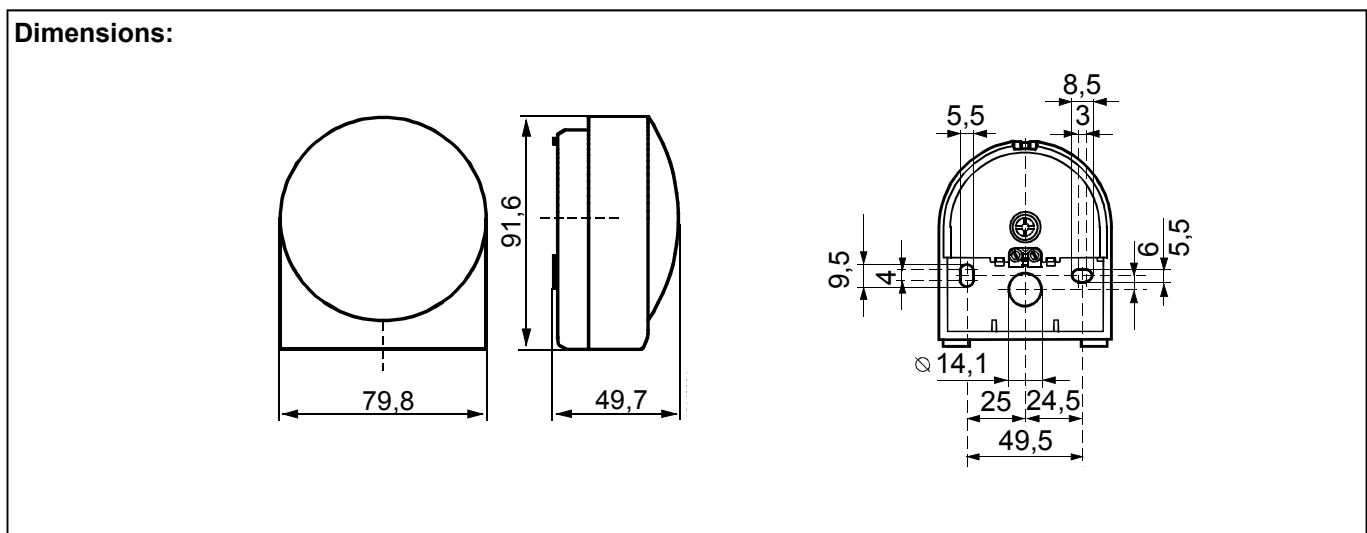

Notes

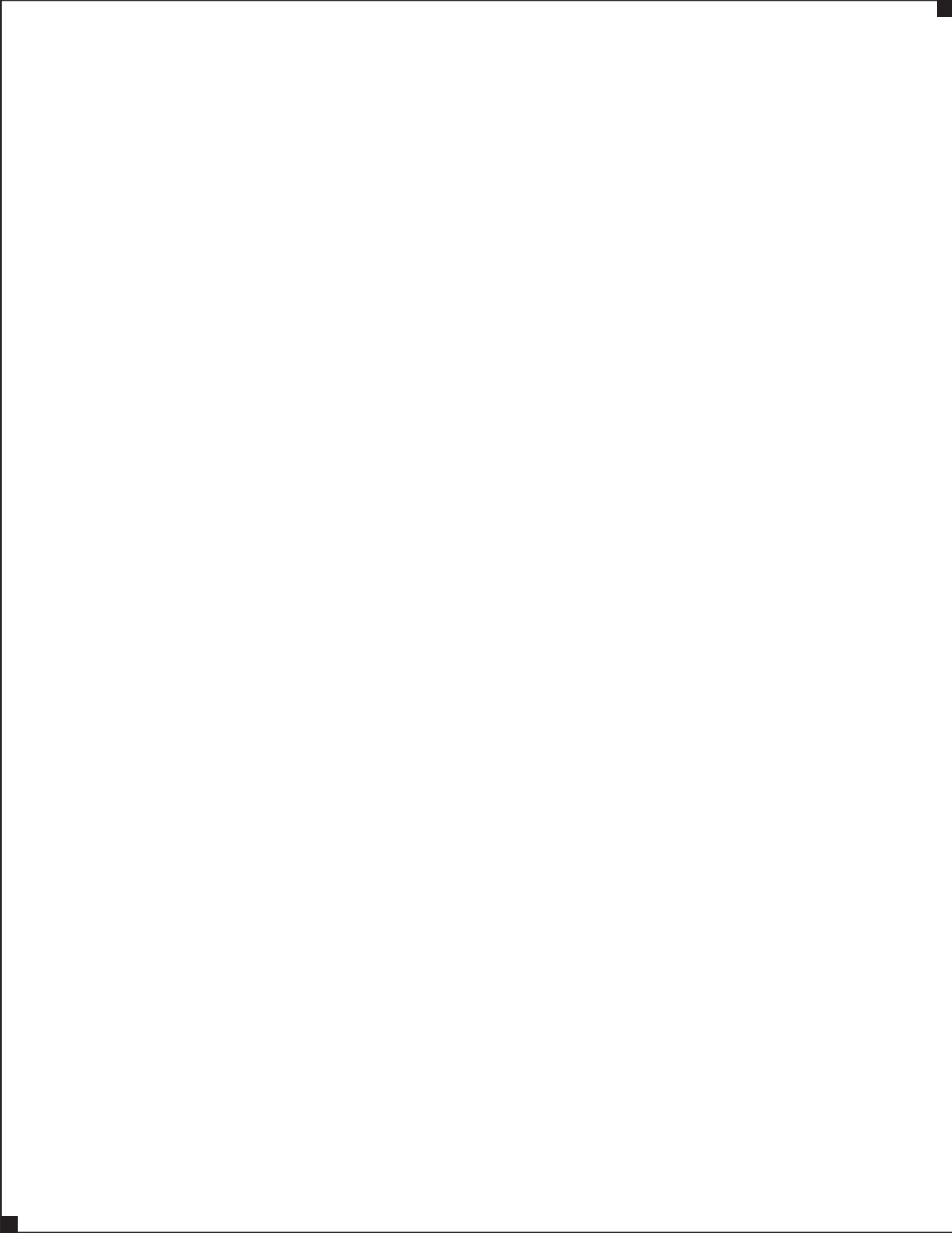

Connect direct





Direct Dial Telephone and Fax Numbers



- boilers
- controllers
- water heaters
- pressurisation sets

Poole Office

Hamworthy Heating Limited
Fleets Corner, Poole, Dorset BH17 0HH England
Main switchboard tel: **01202 662500**

Technical enquiries	 01202 662527/662528	 01202 665111
Spare parts	 01202 662525	 01202 665111
Service department	 01202 662555	 01202 662522



- flue components
- packaged fan dilution systems
- bespoke flue components
- bespoke flue systems
- design and installation

Birmingham Office

Hamworthy Heating Limited
Shady Lane, Great Barr, Birmingham B44 9ER
Main switchboard tel: **0121 360 7000** fax: **0121 325 2309**

General enquiries  **0121 360 7000**

Direct Email Addresses

Customer Services spares@hamworthy-heating.com
service@hamworthy-heating.com
technical@hamworthy-heating.com
sales.flues@hamworthy-heating.com

Hamworthy Heating Accredited Agents

North West England

Gillies Modular Services
210-218 New Chester Road, Birkenhead, Merseyside L41 9BG
tel: **0151 666 1030** fax: **0151 647 8101**

Southern Ireland

HEVAC Limited
Naas Road, Dublin 12, Ireland
tel: **00 3531 141 91919** fax: **00 3531 145 84806**

Northern Ireland

HVAC Supplies Limited
Unit 2, Antrim Line Business Park, Sentry Lane, Newtownabbey BT36 8XX
tel: **02890 849826** fax: **02890 847443**

Scotland

McDowall Modular Services
14-46 Lomond Street, Glasgow, Scotland G22 6JD
tel: **0141 336 8795** fax: **0141 336 8954**

North East England

Allison Heating Products
17 Beech Road, South Shields, Tyne & Wear NE33 2QH
tel: **0191 455 7898** fax: **0191 455 7899**

Website

www.hamworthy-heating.com

Associate Companies, Offices and Agents throughout the World.

Hamworthy reserves the right to make changes and improvements which may necessitate alteration to the specification without prior notice.